

SiSo ROOFTOP ANTENNA

RAIL ROOFTOP ANTENNA WITH OPTIONAL GPS

The SiSo Rooftop Antenna series has been designed specifically for use on trains, trams and buses.

The SiSo range covers 698-960/1710-6000MHz with optional GPS/GNSS with a 26dB LNA. The radiating element is DC grounded and, in versions with a GPS module it is protected by an integrated gas discharge surge arrestor. Housed in a high impact, flame retardant polycarbonate housing, the SiSo series is weatherproof and environmentally sealed to IP67, ensuring that the antenna's performance is never compromised.

Technical Features

- Cellular 700-6000MHz. Covers all LTE, Wi-Fi & WiMAX frequencies used worldwide including GSM-R
- UHF versions covering 380-430MHz OR 450-470MHz are also available on request
- Optional active GPS/GLONASS antenna with built in surge arrestor
- Compliant with rail standards EN45545, EN50155, EN61373 & EN50121
- Rugged flame retardant housing with Polycarbonate 1000 PEI & Aluminium base
- DC grounded antenna
- Industry standard 4 hole mount
- Rated IP67 (When installed according to the installation instructions)

Applications

- High speed trains & locomotives
- Trams
- Buses / coaches
- Mass transit systems
- Heavy duty machinery (quarry trucks etc.)

Ordering Information

SiSo Rooftop Antenna with GPS	1-2823594-1
SiSo Rooftop Antenna without GPS	1-2823593-1

SiSo ROOFTOP ANTENNA

Rail Rooftop Antenna

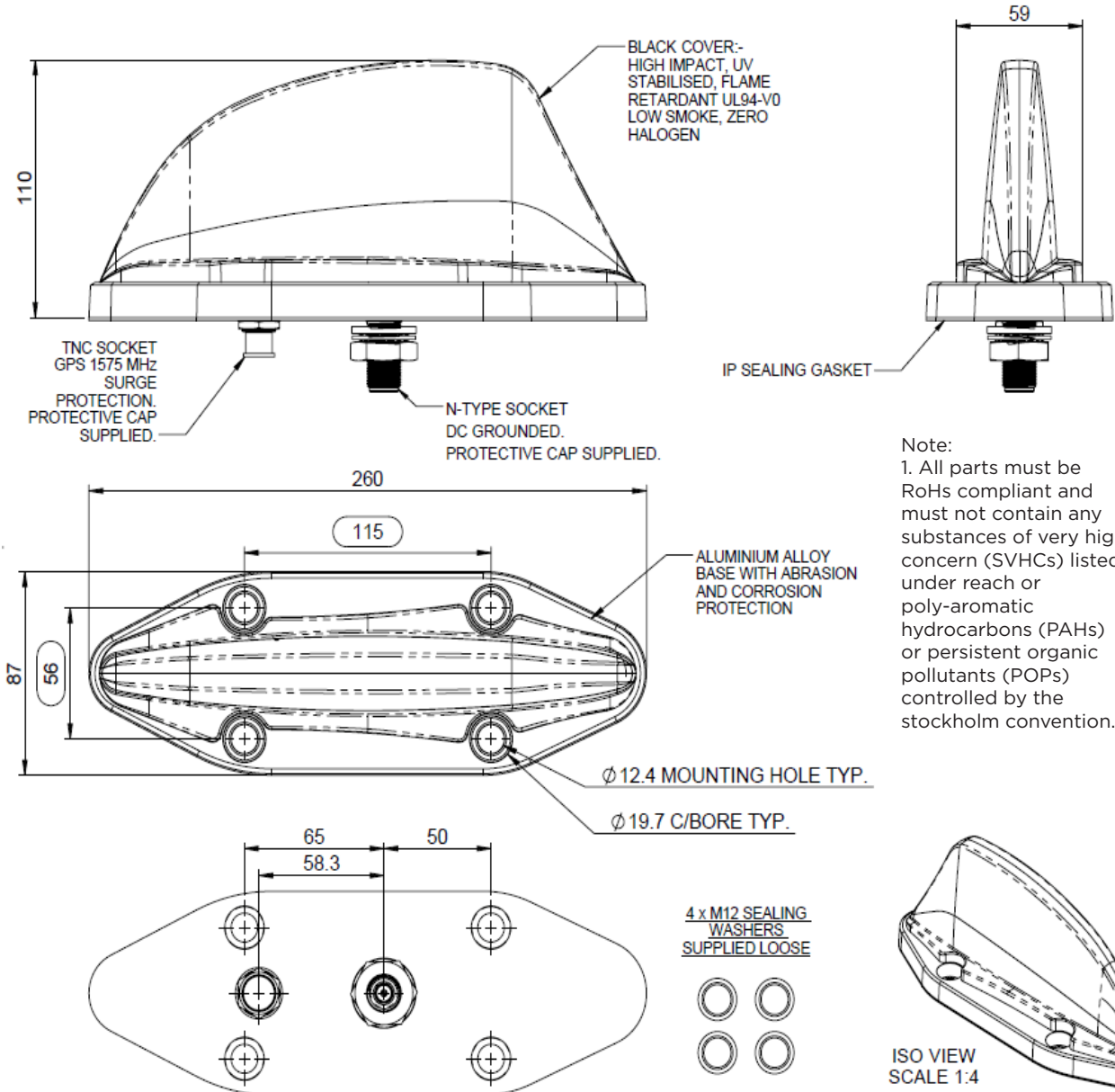

Typical VSWR*

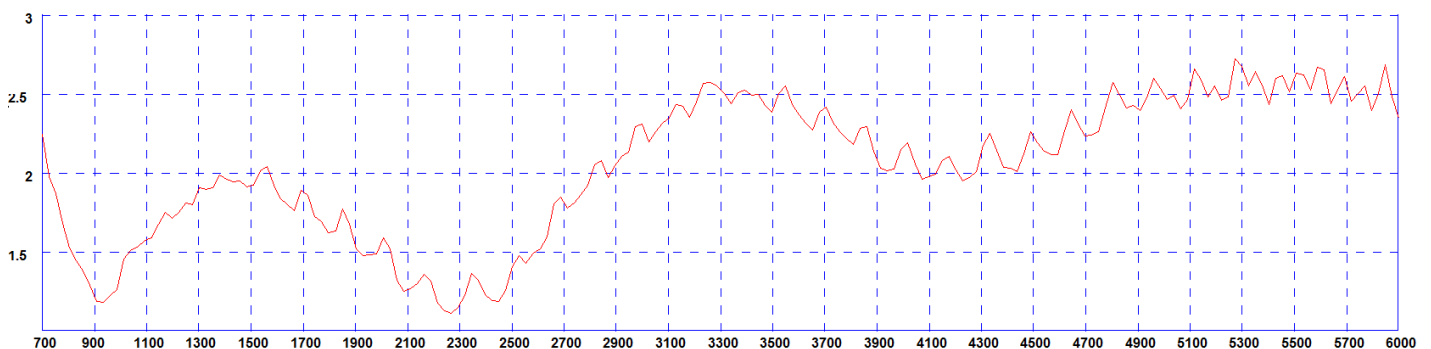

Typical 3D pattern - 700MHz

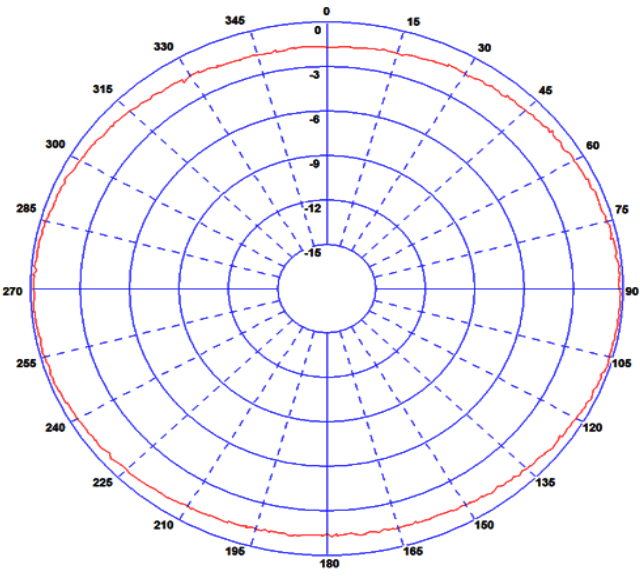

Typical 3D pattern - 800MHz

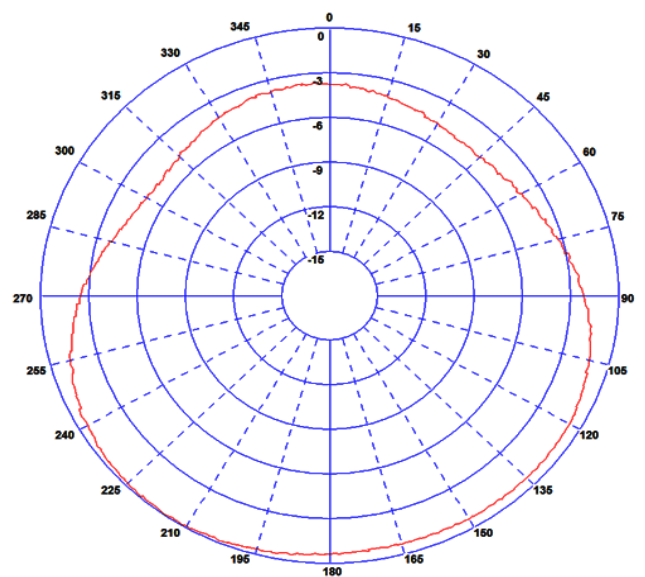

Typical 3D pattern - 900MHz

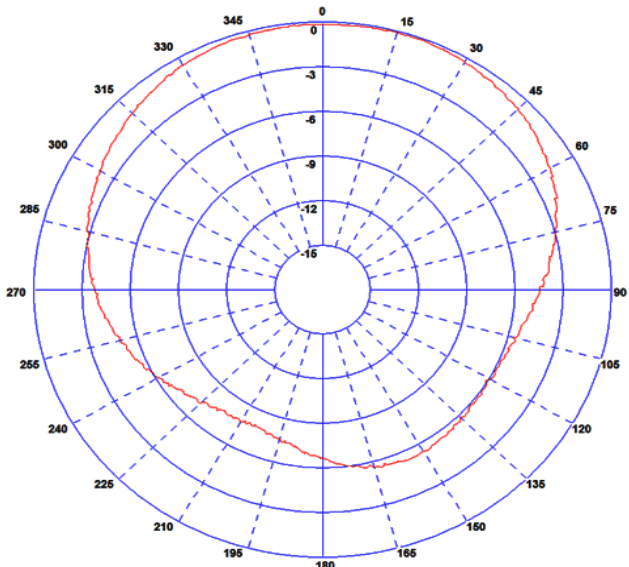

Typical 3D pattern - 1800MHz

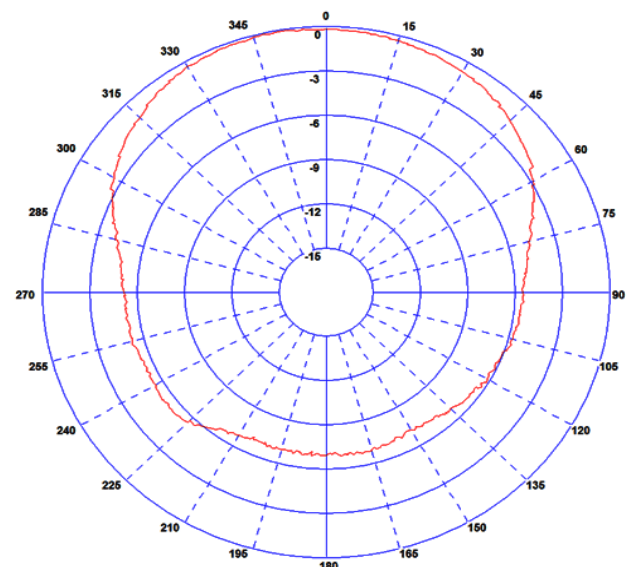

Typical 3D pattern - 2100MHz

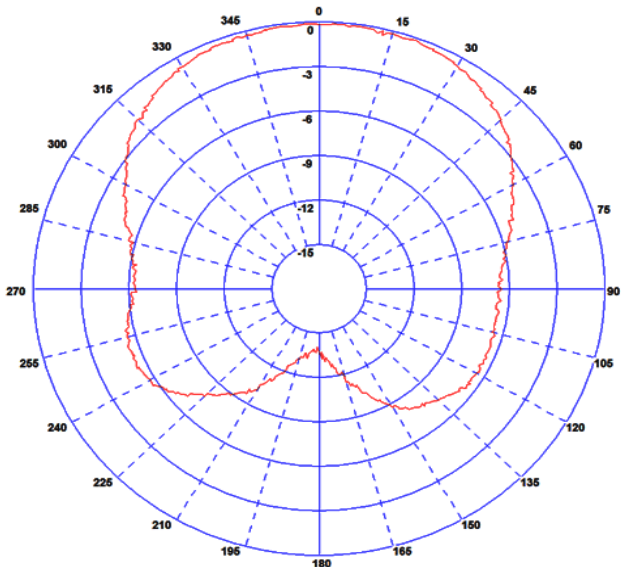

Typical 3D pattern (GPS) - 1575MHz

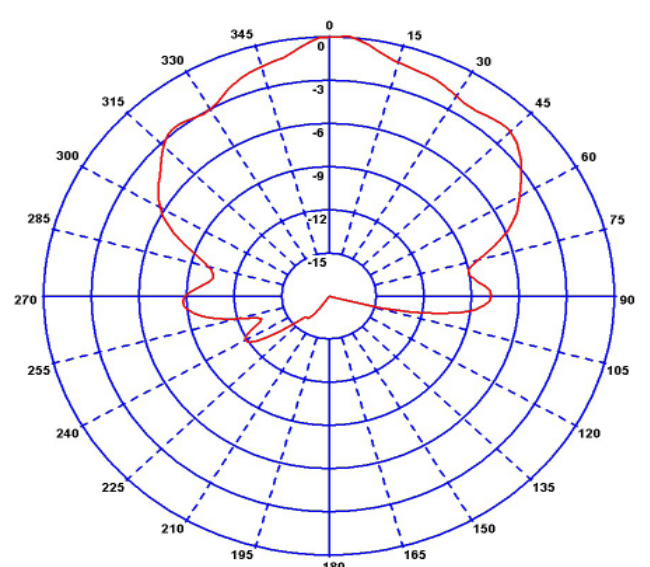

Patterns measured on a 600 x 600mm (2' x 2') ground plane with 1m (3') of low loss cable)

SiSo Rooftop Antenna with GPS

Electrical Data

Frequency Range (MHz)	698-960 / 1710-6000 MHz	
Peak Gain Isotropic**	698-960MHz	5dBi
	1710-2700MHz	7dBi
	4900-6000MHz	10dBi
Polarisation	Vertical	
Typical VSWR*	<2.5:1	
Pattern	Omni-directional	
Impedance	50 Ω	
Max Input Power (W)	60	

GPS Data

Frequency Range (MHz)	1560-1612	
Impedance	50 Ω	
LNA Gain	26dB ± 3	
Polarisation	Right Hand Circular	
Operating Voltage	3-5V DC	
Current (Typical)	15mA	
GPS Antenna EMC Compliance	EN 301 489-1 V1.81 & EN 301 489-3 V1.6.1 EN 50121-3-2:2015	

Mechanical Data

Dimensions	Height (N/inc pad)	110mm (4.33")
	Width	87mm (3.42")
	Length	260mm (10.23")

Environmental Specification

Operating Temp	-40°C / +80°C (-40°F / +176 °F)	
Radome Material	Polycarbonate 1000	
Radome Flame Retardance Rating	V0 (UL94)	
Base Material	Cast Aluminium	
Sealing	IP67 (When installed according to the installation instructions)	

Approvals Data

Regulatory Approvals	EN50155:2007 (Dry heat & Cooling) EN61373:2010 / EN50155:2007 (Shock & Vibration) EN45545:2013 (Fire & Smoke)	
----------------------	---	--

Mounting Data

Fixing	4x mounting holes to suit M12 bolts	
--------	-------------------------------------	--

Termination Data

Termination	Comms	2 x N (female) - DC grounded
	GPS	TNC (female) - surge protected

** Measured on a 600 x 600mm (2' x 2') ground plane without cable.

* Measured on a 600 x 600mm (2' x 2') ground plane with 1m (3') of low loss cable.